

jura[®]



Cool Control 2,5 l

Bedienungsanleitung

Instructions for use

Mode d'emploi

Istruzioni per l'uso

Gebruiksaanwijzing

Modo de empleo

Manual de instruções

Bruksanvisning

Instruksjonsbok

Instrukcja obsługi

Руководство по эксплуатации

Návod k obsluze

JURA Type 586

de

en

fr

it

nl

es

pt

sv

no

pl

ru



cs

Your Cool Control



Control elements	11
Important information	12
Proper use	12
For your safety	12
1 Preparing and using for the first time	14
Setting up and connecting	14
Calibrating the milk level display	14
Preparing the stainless steel container	15
2 Cooling milk	15
Information about using the Cool Control	15
3 Cleaning and maintenance	16
4 Calibrating the milk level display	16
5 Transport and environmentally friendly disposal	16
Transport	16
Disposal	16
6 Technical data	17
7 JURA contact details / legal information	17

Symbol description

Warnings

-  **CAUTION** Always take note of any information marked with the words CAUTION or WARNING and a warning sign. The signal word **WARNING** draws your attention to potential serious injury, and the signal word **CAUTION** to potential minor injury.
 -  **WARNING**
-

Symbols used

-  **Prompt to take action.** This symbol means that you are being prompted to perform some action.
 -  **Information** and tips to make it even easier to use your Cool Control.
-

Control elements

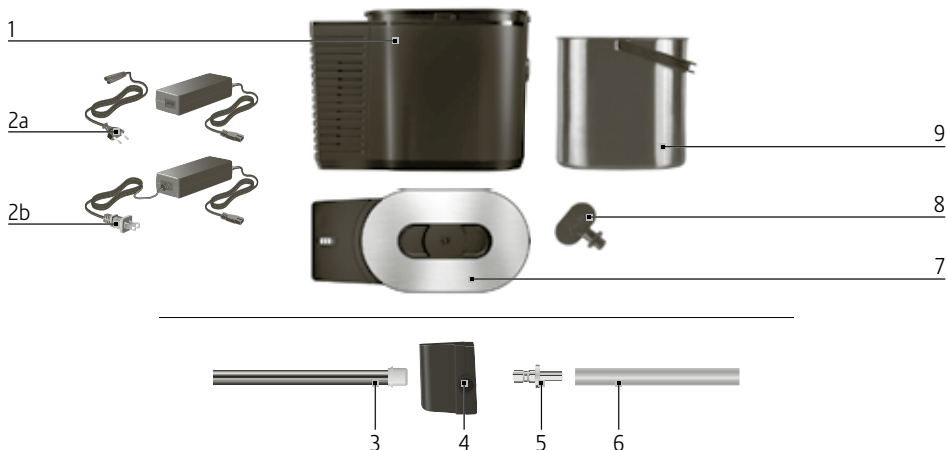

- | | | | |
|----|---|---|---------------------------|
| 1 | Cool Control | 4 | Adapter |
| 2a | Plug-in mains cable with mains adapter
(country-specific versions, not used for USA/
Canada market) | 5 | Connector |
| 2b | Mains cable with mains adapter
(for USA/Canada market only) | 6 | Milk pipe |
| 3 | Metal tube | 7 | Cover (lockable) |
| | | 8 | Hexagon key |
| | | 9 | Stainless steel container |



- | | | | |
|---|---------------------|---|---|
| 1 | Machine cover | 5 | Interface for Wireless Transmitter /
WiFi Connect |
| 2 | Milk level display | 6 | On/Off button  |
| 3 | Temperature display | | |
| 4 | Calibration button | | |

Important information

Proper use

This machine (cold beverage dispenser) is intended for use in the home and similar situations, for example by customers in hotels, motels and other residential buildings, by workers in shops, offices and other working environments, in catering and similar non-retail applications. It should only be used to keep milk cool in the stainless steel container supplied. Use for any other purpose will be deemed improper. JURA cannot accept any responsibility for the consequences of improper use.

Before using the machine, read these instructions for use thoroughly and completely and comply with the instructions they contain. A warranty service is not applicable for damage or defects caused by non-compliance with the instructions for use. Keep these instructions for use close to the machine and pass them on to the next user.

For your safety

Please carefully read and observe the important safety information

set out below. To avoid danger of potentially fatal electric shock:

- Never use a machine which is damaged or has a defective mains cable.
- Never start the machine with wet hands.
- Before starting the machine, ensure that the mains cable is dry.
- The appliance is only to be used with the power supply unit provided with appliance.
- Be careful to ensure that the mains cable is not trapped and does not rub against sharp edges.
- Make sure that the Cool Control and the mains cable are not located close to hot surfaces or naked flames.
- Do not locate multiple portable socket-outlets or portable power supplies at the rear of the Cool Control.
- If the mains cable is damaged, it must be replaced with a special mains cable, which is available directly from JURA or from authorised JURA service centres in order to avoid a hazard.
- In the event of signs of damage, for example if there is a smell of burning, unplug the machine immediately from the power supply and contact JURA service.

- Never open and repair the machine yourself. Do not modify the machine in any way that is not described in the instructions for use. The machine contains live parts. Repairs may only be carried out by authorised JURA service centres, using original spare parts and accessories.

A defective machine is not safe and could cause injury or fire. To avoid damage and any associated risk of injury or fire:

- Ensure that the ventilation slots are not covered.
 - Never allow the mains cable to loosely hang down. The mains cable could pose a tripping hazard or become damaged.
 - Protect your Cool Control from environmental influences such as rain, frost and direct sunlight.
 - Do not immerse the Cool Control, cable or connections in water.
 - Do not put the Cool Control in the dishwasher.
 - Switch your Cool Control off before cleaning and disconnect the mains plug. Always wipe the Cool Control with a damp cloth rather than a wet one, and protect it from prolonged exposure to water splash.
 - Do not pour the milk you want to cool directly into the machine.
- Use the stainless steel container supplied as standard.
- Do not store explosive substances such as spray cans containing flammable propellants in this machine.
 - Only connect the machine to the mains voltage in accordance with the information on the rating plate. The rating plate is located on the underside of your Cool Control. Further technical data is given in these instructions for use (see Chapter 6 'Technical Data').
 - Switch the machine off if you are going to be absent for a long period of time.
 - Only operate the machine when supervised.
 - This appliance is not intended for use by persons (including children) with reduced physical, sensory or mental capabilities, or lack of experience and knowledge, unless they have been given supervision or instruction concerning use of the appliance by a person responsible for their safety. Children should be supervised to ensure that they do not play with the appliance. (The above sentences are according to IEC standard.)
 - This appliance can be used by children aged from 8 years and

above and persons with reduced physical, sensory or mental capabilities or lack of experience and knowledge if they have been given supervision or instruction concerning use of the appliance in a safe way and understand the hazards involved. Children shall not play with the appliance. Cleaning and user maintenance shall not be made by children without supervision. Children aged from 3 to 8 years are allowed to load and unload the Cool Control. (The above sentences are according to EN standard.)

- The insulation blowing gas is flammable, when disposing of the Cool Control, do so only at an authorized waste disposal centre. Do not expose to flame.

To avoid contamination of food, please respect the following instructions:

- Opening the cover for long periods can cause a significant increase of the temperature in the compartments of the Cool Control.
- Clean regularly surfaces that can come in contact with food and accessible drainage systems.
- If the refrigerating appliance is left empty for long periods,

switch off, clean, dry, and leave the cover open to prevent mould developing within the appliance.

1 Preparing and using for the first time

Setting up and connecting

When setting up your Cool Control, please note the following:

- Set the machine down on a firm horizontal surface that is not sensitive to water. The built-in scales for calculating the milk level will only work on a firm surface.
- Choose a spot for your Cool Control which is protected against overheating. Ensure that the ventilation slots are not covered.
- On the Cool Control you will find a label 'Insulation Blowing Gas: CYCLOPENTANE'. This gas is only used during the production process to produce insulating foam. No leakage possible. No refill necessary. There is no expiration date.
- In the interests of hygiene, you should use a damp cloth to clean both the inside and outside of your new machine before starting it. Rinse the stainless steel container out thoroughly.

WARNING

If the machine is operated with a defective mains cable, there is a danger of potentially fatal electric shock.

- ▶ Never use a machine which is damaged or has a defective mains cable.
-
- ▶ Connect the mains cable to the Cool Control.
 - ▶ Insert the mains plug into a power socket.

Calibrating the milk level display

The milk level is calculated based on weight. For this reason, you must calibrate the built-in scales.

- ▶ Remove the stainless steel container with its cover from the Cool Control.

- ▶ Open the machine cover.
- ▶ Press the On/Off button  to switch on the Cool Control.
- ▶ Press the calibration button for about 3 seconds.
An acoustic signal sound. Calibration is now complete.

Preparing the stainless steel container

- ▶ Insert the metal tube into the adapter.

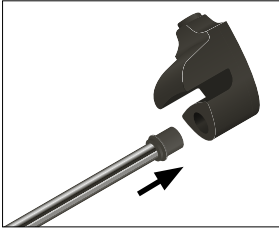

- ▶ Position the adapter on the edge of the stainless steel container.

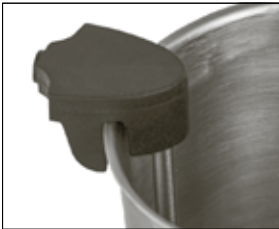



2 Cooling milk

- ▶ Insert the stainless steel container into the Cool Control.
- ▶ Fill the stainless steel container with **cold** milk.

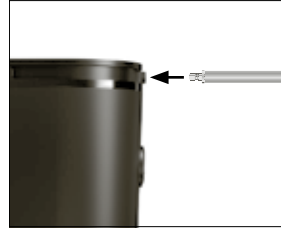

- ▶ Use the cover to close the stainless steel container.
- ▶ Connect the milk pipe of the coffee machine to the adapter.



- i** To connect the milk pipe to the adapter correctly, the pipe must be fitted with a connector.
- ▶ Open the machine cover.
- ▶ Press the On/Off button  to switch on the Cool Control.
- i** To save energy, the cooling process stops as soon as the stainless steel container is removed from the Cool Control.
- i** To switch off the Cool Control, press the On/Off button .
- i** If you want to shut down the machine, remove the mains plug from the power socket.

Information about using the Cool Control

- i** Do not place anything on top of the Cool Control. This will interfere with the built-in scales for calculating the milk level.

Milk temperature:

- The Cool Control cools the milk up to 25 °C below the ambient temperature but not below 4 °C (+/-3 °C). The milk cannot freeze.
- Underneath the machine cover is the milk temperature display. You can choose between °C and °F. To switch between the two displays, press the calibration button.

After preparation, an **acoustic signal** sounds and the milk level display lights up red:

- Add **cold** milk to the stainless steel container.

Information on hygiene when handling milk:

- Do not keep filling the container with milk. Milk that has been in the container for a long time can go sour.
- If there is still milk in the container after use, store the milk in another receptacle, not in the stainless steel container.
- We recommend emptying and cleaning the stainless steel container every day.

Optional – Connecting the Cool Control to the coffee machine (Bluetooth or WiFi network):

- **Connecting via Bluetooth:** To do this, you need the optionally available **Wireless Transmitter** from JURA. Your coffee machine must be equipped with the **JURA Smart Connect**. This accessory is available from specialised dealers. Please note that you can only connect either the Cool Control or J.O.E.® – your JURA app – to the coffee machine via Smart Connect.
- **Connecting via a WiFi network:** To do this, equip both your Cool Control and your coffee machine with **JURA WiFi Connect**. This accessory is available from specialised dealers.
- If the stainless steel container is empty, this is displayed in the coffee machine display.

i If you experience any general problems with the JURA Wireless transmitter / JURA WiFi Connect (e.g. a connection problem), it can be reset to the factory setting. Press the On/Off button  for **approx. 3 sec.**

3 Cleaning and maintenance

- i** Do not use harsh or abrasive cleaning agents or hard objects to clean the machine. This may damage the machine, the coating of the stainless steel container holder and the stainless steel container.
- i** The stainless steel container, adapter and metal tube are dishwasher-safe.
 - ▶ Before cleaning the machine, remove the mains plug from the power socket.

- ▶ Clean the inside of the machine with a damp cloth.
- ▶ Clean the outside of the machine with a damp cloth.
- ▶ Rinse all individual parts thoroughly under running water.

4 Calibrating the milk level display

The milk level is calculated based on weight. If the milk fill volume is no longer displayed correctly, you must recalibrate the built-in scales (see chapter 1 ‘Preparing and using for the first time – Calibrating the milk level display’).

5 Transport and environmentally friendly disposal

Transport

Keep the packaging for your Cool Control. It should be used to protect the machine during transport. Clean the stainless steel container before transporting it.





Disposal

Correct disposal of this product:



This marking indicates that this product should not be disposed with other household wastes throughout the EU. To prevent possible harm to the environment or human health from uncontrolled waste disposal, recycle it responsibly to promote the sustainable reuse of material resources. To return your used device, please use the return and collection systems or contact the retailer where the product was purchased. They can take this product for environmental safe recycling.

6 Technical data

Voltage	100–240 V ~, 50/60 Hz
Conformity marking	   
Power	50 W
Holding capacity of stainless steel container	2.5 l
Cable length	approx. 3.3 m
Weight	approx. 3.4 kg
Dimensions (W × H × D)	15.0 × 23.4 × 31.9 cm
Climate class	T (for ambient temperatures from +16 °C up to +43 °C); cools up to 25 °C below the ambient temperature, but no lower than 4 °C (+/-3 °C).

Technical changes

We reserve the right to make technical changes. The diagrams used in these instructions for use are for illustration purposes only and do not represent the original colours of the machine. Some details of your machine may vary.

Feedback

Your opinion is important to us! Use the contact details at jura.com.

7 JURA contact details / legal information

JURA Elektroapparate AG
 Kaffeeweltstrasse 10
 CH-4626 Niederbuchsiten
 Tel. +41 (0)62 38 98 233

You will find additional contact details for your country at jura.com.

Directives

The machine complies with the following directives:

- 2011/65/EU (RoHS)
- 1907/2006/EC (REACH)
- 2014/35/EU (Low Voltage Directive)
- 2014/30/EU (Electromagnetic Compatibility)
- 2009/125/EC (Ecodesign Directive)